

## FLOORSTANDING CENTRIFUGES

# — ROTO SILENTA 630 RS

### YOUR FIRST CHOICE UP TO 12 LITERS

The ROTO SILENTA 630 RS is highly rated in the rapid and efficient centrifugation of blood bags. It is able to spin up to 12 liters of sample or 12 blood bags per run. Four and six-place rotor options are also available to offer the best possible fit.

In industrial or R&D settings the ROTO SILENTA accommodates six vessels up to 2,000 ml each.

This unit includes refrigeration with a temperature range from -20°C to +40°C.



### — HIGHLIGHTS

- RPM: 50 - 6,000 min<sup>-1</sup>  
Adjustable in increments of 10
- RCF: 50 - 6,520  
Adjustable in increments of 1
- max. Capacity: 6 x 2,000 ml
- the first choice in blood banking centrifuges
- Choice of 3 rotors
- Registered Medical Device
- easy operation with keypad and control knob
- 89 program memories for more individuality
- 9 acceleration + 19 deceleration stages
- coolable from -20 bis +40 °C with pre-cooling function
- data reporting system (optional)

### — FEATURES

- metal housing and lid
- large viewing port in the lid
- powered lid lock
- lid dropping protection
- emergency lid lock release
- stainless steel chamber
- automatic rotor recognition
- brushless drive
- error display
- display in °C and °F possible
- imbalance detection and switch-off

## TECHNICAL DATA

### ROTO SILENTA 630 RS <sup>>)</sup> refrigerated

voltage <sup>*)</sup>	400 V 3 ~ + N
frequency	50 – 60 Hz
consumption	9,700 VA
emission, immunity	EN/IEC 61326-1, class B
max. capacity	6 x 2,000 ml
max. RPM	6,000 min <sup>-1</sup>
max. RCF	6,520
running time	1 – 999 min: 59 s, ∞ continuous run
dimensions (WxDxH)	813 x 1,015 x 973 mm
weight	approx. 355 kg
temperature control, infinitely variable	from -20 to +40 °C

<b>Cat. No.</b>	<b>5005</b>
-----------------	-------------

208 – 220 V +6 / -10 % 3- (+N) + PE,  
with internal transformer

5005-08

consumption

9,000 VA

weight



approx. 401 kg

<sup>\*)</sup> Other voltages on request.

<sup>>)</sup> Other models on request.

## AVAILABLE ROTORS

### SWING-OUT ROTORS

		angle	max. RPM	max. capacity	Cat. No.	page
	swing-out rotor, 6-place	90°	4,500 min <sup>-1</sup>	6 x 2,000 ml	<b>4176</b>	3
	swing-out rotor, 4-place	90°	4,500 min <sup>-1</sup>	4 x 1,600 ml	<b>4174</b>	3

### ANGLE ROTORS

	angle rotor, 6-place	25°	6,000 min <sup>-1</sup>	6 x 250 ml	<b>4570</b>	9
---	----------------------	-----	-------------------------	------------	-------------	---

— SWING-OUT ROTOR, 6- / 4-PLACE | 4176 / 4174



<b>Rotor</b>	
max. RPM	4,500 min <sup>-1</sup>
max. RCF	Rotor 4176 / 4174 6,498 / 5,683
max. capacity	12 / 8 blood bag
run-up   run-down, braked in sec	125   197
angle   temperature in °C <sup>1)</sup>	90°   +16 / +10
<b>Cat. No.</b>	<b>4176 / 4174</b>

<b>Bucket</b>	
<b>Cat. No.</b>	<b>4524-A</b>

<b>Blood bag</b>				
capacity in ml		500	500	750
blood bag per system		4-place	4-place	1-place
max. RCF <sup>26)</sup>	Rotor 4176 / 4174	6,498 / 5,683	6,498 / 5,683	6,498 / 5,683
radius in mm		287 / 251	287 / 251	287 / 251
<b>Cat. No.</b>		-	-	-

<b>Insert</b>				
boring Ø x L in mm		-	-	-
blood bag systems per rotor		12 / 8	12 / 8	12 / 8
<b>Cat. No.</b>		<b>4529<sup>26)</sup>-AO,-AM,-AU</b>	<b>4592-B</b>	<b>4592-B</b>

+ Additional blood bank accessories can be found on [page 185](#)

— SWING-OUT ROTOR, 6- / 4-PLACE | 4176 / 4174

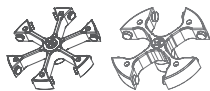

<b>Rotor</b>	
max. RPM	4,500 min <sup>-1</sup>
max. RCF	Rotor 4176 / 4174 6,271 / 5,479
max. capacity	12 / 8 blood bag
run-up   run-down, braked in sec	125   197
angle   temperature in °C <sup>1)</sup>	90°   +10 / 0
<b>Cat. No.</b>	<b>4176 / 4174</b>

<b>Bucket</b>	
<b>Cat. No.</b>	<b>4546-A</b>



<b>Blood bag</b>		
capacity in ml		450
blood bag per system		4-place
max. RCF	Rotor 4176 / 4174	6,271 / 5,479
radius in mm		277 / 242
<b>Cat. No.</b>		-

<b>Insert</b>		
boring Ø x L in mm		-
blood bag systems per rotor		12 / 8
<b>Cat. No.</b>		<b>4559-A</b>



+ Additional blood bank accessories can be found on [page 185](#)



- 1) For cooled versions: Lowest temperature achievable with precooling and max. speed.
- 26) Includes blood bag hanging to prevent erythrocyte accumulation at low speeds. Different hanging heights allow customer-specific adjustments. (4529-AO top, 4529-AM center, 4529-AU bottom). Hanging blood bags may be centrifuged with a maximum RCF of 1,000.

— SWING-OUT ROTOR, 6- / 4-PLACE | 4176 / 4174

			
<b>Rotor</b>		<b>Bucket</b>	
max. RPM	4,500 min <sup>-1</sup>	<b>Cat. No.</b>	<b>4591-A</b>
max. RCF Rotor 4176 / 4174	6,498 / 5,705		
max. capacity	12 / 8 blood bag		
run-up   run-down, braked in sec	125   197		
angle   temperature in °C <sup>1)</sup>	90°   +16 / +10		
<b>Cat. No.</b>	<b>4176 / 4174</b>		





			
<b>Blood bags</b>			
capacity in ml	450	500	750
blood bag per system	3-place	4-place	1-place
max. RCF Rotor 4176 / 4174	6,271 / 5,705	6,498 / 5,705	6,498 / 5,705
radius in mm	287 / 252	287 / 251	287 / 251
<b>Cat. No.</b>	<b>-</b>	<b>-</b>	<b>-</b>



			
<b>Insert</b>			
boring Ø x L in mm	-	-	-
blood bag systems per rotor	12 / 8	12 / 8	12 / 8
<b>Cat. No.</b>	<b>4598-A</b>	<b>4592-B</b>	<b>4592-B</b>

+ Additional blood bank accessories can be found on [page 185](#)

— SWING-OUT ROTOR, 6- / 4-PLACE | 4176 / 4174

			
<b>Rotor</b>		<b>Bucket</b>	
max. RPM	3,500 min <sup>-1</sup>	<b>Cat. No.</b>	<b>4595-C<sup>31)</sup></b>
max. RCF Rotor 4176 / 4174	3,848 / 3,328		
max. capacity	6 x 2,000 ml		
angle   temperature in °C <sup>1)</sup>	90°   +16 / -12		
<b>Cat. No.</b>	<b>4176 / 4174</b>		



		
<b>Vessels</b>		
capacity in ml	max. 1,600 <sup>35)</sup>	2,000
W x D x H in mm	-	150 x 100 x 180
max. RCF Rotor 4176 / 4174	3,821 / 3,328	3,848 / -
radius in mm	279 / 243	281 / -
run-up, in sec	95 / 131	95 / -
run-down, braked in sec	131 / 131	41 / -
<b>Cat. No.</b>	<b>-</b>	<b>0550<sup>24)</sup></b>

		
<b>Insert</b>		
W x D x H in mm	145 x 91 x 146	-
vessels per rotor	6 / 4	6 / -
<b>Cat. No.</b>	<b>4596-A</b>	<b>-</b>

- 1) For cooled versions: Lowest temperature achievable with precooling and max. speed.
- 24) At temperatures of over +40 °C and / or when not filled to capacity, bottles may warp during centrifugation.
- 31) Adapter for accommodating sample tubes and blood collection tubes in carrier 4595-C on request.
- 35) Depending on the sample.

— SWING-OUT ROTOR, 6- / 4-PLACE | 4176 / 4174



<b>Rotor</b>	
max. RPM	4,500 min <sup>-1</sup>
max. RCF Rotor 4176 / 4174	6,520 / 5,705
max. capacity	6 / 4 blood bag
run-up   run-down, braked in sec	125   197
angle   temperature in °C <sup>1)</sup>	90°   +9 / +3
<b>Cat. No.</b>	<b>4176 / 4174</b>

<b>Bucket</b>	
<b>Cat. No.</b>	<b>4523-A</b>

<b>Blood bags</b>			
capacity in ml	500	750	1,000
blood bag per system	4-place	1-place	1-place
max. RCF Rotor 4176 / 4174	6,475 / 5,660	6,475 / 5,660	6,520 / 5,705
radius in mm	285 / 250	285 / 250	288 / 252
<b>Cat. No.</b>	<b>-</b>	<b>-</b>	<b>-</b>

<b>Insert</b>			
boring Ø x L in mm	-	-	-
blood bag systems per rotor	6 / 4	6 / 4	6 / 4
<b>Cat. No.</b>	<b>4516-A</b>	<b>4516-A</b>	<b>-</b>

+ Additional blood bank accessories can be found on [page 185](#)

— SWING-OUT ROTOR, 6- / 4-PLACE | 4176 / 4174

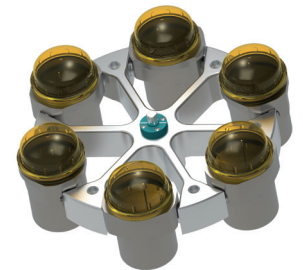
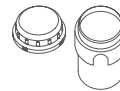
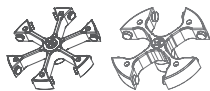

<b>Rotor</b>	
max. RPM	4,500 min <sup>-1</sup>
max. RCF Rotor 4176 / 4174	6,316 / 5,524
max. capacity	6 / 4 blood bag
run-up   run-down, braked in sec	125   197
angle   temperature in °C <sup>1)</sup>	90°   +9 / -9
<b>Cat. No.</b>	<b>4176 / 4174</b>

<b>Bucket</b>	
lid	5621
<b>Cat. No.</b>	<b>4547-B</b>

<b>Blood bags</b>		
capacity in ml	500	450
blood bag per system	4-place	3-place
max. RCF Rotor 4176 / 4174	6,316 / 5,524	6,316 / 5,524
radius in mm	279 / 244	279 / 244
<b>Cat. No.</b>	<b>-</b>	<b>-</b>

<b>Insert</b>		
boring Ø x L in mm	-	-
blood bag systems per rotor	6 / 4	6 / 4
<b>Cat. No.</b>	<b>4548</b>	<b>4548</b>

+ Additional blood bank accessories can be found on [page 185](#)

1) For cooled versions: Lowest temperature achievable with precooling and max. speed.

## SWING-OUT ROTOR, 6- / 4-PLACE | 4176 / 4174



<b>Rotor</b>	
max. RPM	4,500 min <sup>-1</sup>
max. RCF Rotor 4176 / 4174	6,294 / 5,501
max. capacity	6/4 x 1,000 ml
run-up   run-down, braked in sec	125   197
angle   temperature in °C <sup>1)</sup>	90°   +4 / -11
<b>Cat. No.</b>	<b>4176 / 4174</b>



<b>Bucket</b>	
adapter including lid	4255
<b>Cat. No.</b>	<b>4579-A</b>

<b>Vessels</b>																
capacity in ml		5	7	9	15	25	50	100	2.6-3.4	2.7-3	4-5.5	4.5-5	4.9	9-10	10	1.6-5
Ø x L in mm		12x75	12x100	14x100	17x100	24x100	34x100	44x100	13 x 65	11 x 66	15x75	11x92	13x90	16x92	15x102	13x75
max. RCF <sup>2)</sup> Rotor 4176 / 4174		5,750 / 4,935	5,750 / 4,935	5,886 / 5,094	5,886 / 5,094	5,615 / 4,845	5,705 / 4,890	5,683 / 4,867	5,750 / 4,935	5,750 / 4,935	5,886 / 5,094	5,750 / 4,935	5,750 / 4,935	5,886 / 5,094	5,886 / 5,094	5,750 / 4,935
radius in mm		254 / 218	254 / 218	260 / 225	260 / 225	248 / 214	252 / 216	251 / 215	254 / 218	254 / 218	260 / 225	254 / 218	254 / 218	260 / 225	260 / 225	254 / 218
<b>Cat. No.</b>		<b>tubes<sup>2)</sup></b>							<b>blood collection / urine tubes</b>							

<b>Adapter</b>																
boring Ø x L in mm		13 x 58	13 x 58	17,5 x 60	17,5 x 60	26 x 72	36 x 79	45 x 78	13,5 x 58	13 x 58	17,5 x 60	13 x 58	13,5 x 58	17,5 x 60	17,5 x 60	13,5 x 58
vessels per rotor		180 / 120	180 / 120	114 / 76	114 / 76	42 / 28	24 / 16	12 / 8	126 / 84	180 / 120	114 / 76	180 / 120	126 / 84	114 / 76	114 / 76	126 / 84
<b>Cat. No.</b>		<b>4433</b>	<b>4433</b>	<b>4434</b>	<b>4434</b>	<b>4438</b>	<b>4439</b>	<b>4442</b>	<b>4435</b>	<b>4433</b>	<b>4434</b>	<b>4433</b>	<b>4435</b>	<b>4434</b>	<b>4434</b>	<b>4435</b>

<b>Vessels</b>																
capacity in ml		4-7	4-7	8.5-10	15	50	25	30	10	250	290	650 <sup>3.15)</sup>	750 <sup>3.15)</sup>	1,000 <sup>3.15)</sup>	1,000	175 <sup>3.15)</sup>
Ø x L in mm		13x100	16x75	16x100	17x120	29x115	25x90	25 x 110	16 x 80	61 x 122	62 x 137	97 x 139	97 x 152	96 x 176	98 x 138	61 x 118
max. RCF <sup>2)</sup> Rotor 4176 / 4174		5,750 / 4,935	5,886 / 5,094	5,886 / 5,094	6,022 / 5,207	5,999 / 5,207	5,818 / 5,026	5,818 / 5,026	5,886 / 5,094	6,113 / 5,320	6,113 / 5,320	5,999 / 5,184	6,294 / 5,501	6,294 / 5,501	6,294 / 5,501	6,294 / 5,501
radius in mm		254 / 218	260 / 225	260 / 225	266 / 230	265 / 230	257 / 222	257 / 222	260 / 225	270 / 235	270 / 235	265 / 229	278 / 243	278 / 243	278 / 243	278 / 243
<b>Cat. No.</b>		<b>blood collection / urine tubes</b>			<b>tubes with screw cap</b>				<b>5127<sup>2a)</sup></b>	<b>-<sup>2a)</sup></b>	<b>0554<sup>2a)</sup></b>	<b>0512<sup>2a)</sup></b>	<b>4239<sup>2a)</sup></b>	<b>4255</b>	<b>Falcon</b>	

<b>Adapter</b>																
boring Ø x L in mm		13,5 x 58	17,5 x 60	17,5 x 60	17 x 86	30 x 87	26 x 72	26 x 72	17,5 x 60	62 x 92	62 x 92	98 x 138	98 x 138	98 x 138	-	61 x 118
vessels per rotor		126 / 84	114 / 76	114 / 76	72 / 48	30 / 20	42 / 28	42 / 28	114 / 76	6 / 4	6 / 4	6 / 4	6 / 4	6 / 4	6 / 4	6 / 4
<b>Cat. No.</b>		<b>4435</b>	<b>4434</b>	<b>4434</b>	<b>4437</b>	<b>4441</b>	<b>4438</b>	<b>4438</b>	<b>4434</b>	<b>4443</b>	<b>4443</b>	<b>4258</b>	<b>-</b>	<b>-</b>	<b>-</b>	<b>4440</b>

<b>Vessels</b>						
capacity in ml		175	200	225	250	500
Ø x L in mm		61.5x144	60 x 130	61 x 137	60 x 162	96 x 147
max. RCF <sup>2)</sup> Rotor 4176 / 4174		6,294 / 5,501	6,294 / 5,501	6,294 / 5,501	6,294 / 5,501	6,294 / 5,501
radius in mm		278 / 243	278 / 243	278 / 243	278 / 243	278 / 243
<b>Cat. No.</b>		<b>Nalgene®</b>	<b>Nunc®</b>	<b>Falcon®</b>	<b>Corning®</b>	<b>Corning®</b>

<b>Adapter</b>						
boring Ø x L in mm		-	-	-	-	-
vessels per rotor		6 / 4	6 / 4	6 / 4	6 / 4	6 / 4
<b>Cat. No.</b>		<b>4430</b>	<b>4430</b>	<b>4440</b>	<b>4430</b>	<b>4449</b>

- 1) For cooled versions: Lowest temperature achievable with precooling and max. speed.
- 2) Please note that the RCF values indicated refer only to rotor performance. The max. permissible RCF of tubes used should be verified with the individual manufacturers.  
The max. RCF for glass tubes annotated with footnote 2) is 4,000.
- 3.15) When using these tubes, carrier 4255 cannot be closed with its lid.
- 24) At temperatures of over +40 °C and / or when not filled to capacity, bottles may warp during centrifugation.

— SWING-OUT ROTOR, 6- / 4-PLACE | 4176 / 4174

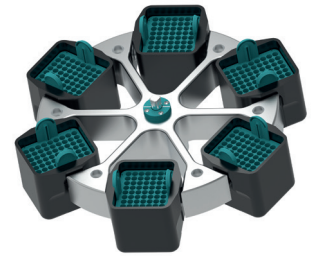

Rotor	
max. RPM	4,500 min <sup>-1</sup>
max. RCF Rotor 4176 / 4174	5,999 / 5,184
max. capacity	6x750 ml
run-up   run-down, braked in sec	125   197
angle   temperature in °C <sup>1)</sup>	90°   +14 / -1
<b>Cat. No.</b>	<b>4176 / 4174</b>

Bucket	
<b>Cat. No.</b>	<b>4522-A</b>

Vessels															
capacity in ml	4	5	6	7	12	15	25	50	100	2.6-3.4	2.7-3	4-5.5	4.5-5	7.5-8.5	9-10
Ø x L in mm	10x88	12x75	12x82	12x100	16x101	17x100	24x100	34x100	44x115	13x65	11x66	15x75	11x92	15x92	16x92
max. RCF Rotor 4176 / 4174	5,818 / 5,003	5,818 / 5,003	5,818 / 5,003	5,818 / 5,003	5,818 / 5,003	5,818 / 5,003	5,818 / 5,003	5,818 / 5,003	5,818 / 5,003	5,818 / 5,003	5,818 / 5,003	5,818 / 5,003	5,818 / 5,003	5,818 / 5,003	5,818 / 5,003
radius in mm	257 / 221	257 / 221	257 / 221	257 / 221	257 / 221	257 / 221	257 / 221	257 / 221	257 / 221	257 / 221	257 / 221	257 / 221	257 / 221	257 / 221	257 / 221
<b>Cat. No.</b>	<b>tubes<sup>2)</sup></b>								<b>blood collection / urine tubes</b>						

Adapter															
boring Ø x L in mm	11 x 70	12.5 x 32	12.5 x 70	12.5 x 70	16x70	17.5x70	26x70	35x70	41.5x70	13.2x32	12.5x32	17.5x32	12.5 x 70	17.5 x 70	17.5 x 70
vessels per rotor	378 / 252	288 / 192	288 / 192	288 / 192	150 / 100	180 / 120	66 / 44	36 / 24	24 / 16	180 / 120	288 / 192	180 / 120	288 / 192	180 / 120	96 / 64
<b>Cat. No.</b>	<b>4224</b>	<b>4213-93</b>	<b>4213</b>	<b>4213</b>	<b>4223</b>	<b>4214</b>	<b>4215</b>	<b>4216</b>	<b>4218</b>	<b>4222-93</b>	<b>4213-93</b>	<b>4214-93</b>	<b>4213</b>	<b>4214</b>	<b>4220</b>

Vessels															
capacity in ml	10	1.6-5	4-7	4-7	8	8.5-10	15	50	12	30	50	250	290	600	650
Ø x L in mm	15x102	13x75	16x75	13x100	16x125	16x100	17x120	29x115	17 x 100	25 x 110	29x115	61 x122	62 x 137	93x134	97 x 139
max. RCF Rotor 4176 / 4174	5,818 / 5,003	5,818 / 5,003	5,818 / 5,003	5,818 / 5,003	5,818 / 5,003	5,818 / 5,003	5,999 / 5,184	5,999 / 5,184	5,818 / 5,003	5,818 / 5,003	5,909 / 5,094	5,818 / 5,003	5,818 / 5,003	5,999 / 5,184	5,999 / 5,184
radius in mm	257 / 221	257 / 221	257 / 221	257 / 221	257 / 221	257 / 221	265 / 229	265 / 229	257 / 221	257 / 221	261 / 225	257 / 221	257 / 221	265 / 229	265 / 229
<b>Cat. No.</b>	<b>blood collection / urine tubes</b>						<b>tubes with screw cap</b>				<b>5127<sup>24)</sup></b>	<b>-<sup>24)</sup></b>	<b>0551<sup>24)</sup></b>	<b>0554<sup>24)</sup></b>	

Adapter															
boring Ø x L in mm	17.5x70	13.2x32	17.5x32	13.2x70	16x70	17.5x70	17x70	30 x 70	17.5x70	26 x 70	30 x 96	62 x 90	62 x 90	94x105	97.5x105
vessels per rotor	180 / 120	180 / 120	180 / 120	180 / 120	150 / 100	180 / 120	138 / 92	48 / 32	96 / 64	66 / 44	36 / 24	6 / 4	6 / 4	6 / 4	6 / 4
<b>Cat. No.</b>	<b>4214</b>	<b>4222-93</b>	<b>4214-93</b>	<b>4222</b>	<b>4223</b>	<b>4214</b>	<b>4232</b>	<b>4245-A</b>	<b>4220</b>	<b>4215</b>	<b>4249</b>	<b>4238</b>	<b>4238</b>	<b>4233</b>	<b>4258</b>

Vessels				
capacity in ml	750	750	250	500
Ø x L in mm	97 x 152	96 x 135	60 x 162	96 x 147
max. RCF Rotor 4176 / 4174	5,999 / 5,184	5,999 / 5,184	5,818 / 5,003	5,999 / 5,184
radius in mm	265 / 229	265 / 229	257 / 221	265 / 229
<b>Cat. No.</b>	<b>0512<sup>24)</sup></b>	<b>4234-A</b>	<b>Corning®</b>	<b>Corning®</b>

Adapter				
boring Ø x L in mm	97.5x105	97.5x105	60x125	97.5x105
vessels per rotor	6 / 4	6 / 4	6 / 4	6 / 4
<b>Cat. No.</b>	<b>4258</b>	<b>4258</b>	<b>6322</b>	<b>4258</b>

- 1) For cooled versions: Lowest temperature achievable with precooling and max. speed.
- 2) Please note that the RCF values indicated refer only to rotor performance. The max. permissible RCF of tubes used should be verified with the individual manufacturers. The max. RCF for glass tubes annotated with footnote 2) is 4,000.
- 5) Tested by the TÜV in conformity with DIN EN 61010, section 2 - 020.
- 24) At temperatures of over +40 °C and / or when not filled to capacity, bottles may warp during centrifugation.

## SWING-OUT ROTOR, 6- / 4-PLACE | 4176 / 4174

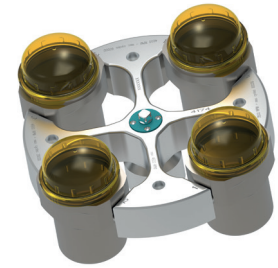
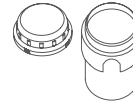

Rotor	
max. RPM	4,500 min <sup>-1</sup>
max. RCF Rotor 4176 / 4174	6,384 / 5,592
max. capacity	6 x 1,000 ml
run-up   run-down, braked in sec	125   197
angle   temperature in °C <sup>1)</sup>	90°   +9 / -9
<b>Cat. No.</b>	<b>4176 / 4174</b>

Bucket	
lid	5621
<b>Cat. No.</b>	<b>4547-B</b>

Vessels															
capacity in ml	5	7	9	15	25	50	100	2.6-3.4	2.7-3	4-5.5	4.5-5	4.9	7.5-8.2	9-10	10
Ø x L in mm	12x75	12x100	14x100	17x100	24x100	34x100	44x100	13 x 65	11x66	15x75	11x92	13x90	15x92	16x92	15x102
max. RCF <sup>2)</sup> Rotor 4176 / 4174	5,841 / 5,026	5,841 / 5,026	5,977 / 5,184	5,977 / 5,184	5,728 / 4,913	5,773 / 4,981	5,750 / 4,958	5,841 / 5,026	5,841 / 5,026	5,977 / 5,184	5,841 / 5,026	5,841 / 5,026	5,977 / 5,184	5,977 / 5,184	5,977 / 5,184
radius in mm	258 / 222	258 / 222	264 / 229	264 / 229	253 / 217	255 / 220	254 / 219	258 / 222	258 / 222	264 / 229	258 / 222	258 / 222	264 / 229	264 / 229	264 / 229
<b>Cat. No.</b>	<b>tubes<sup>2)</sup></b>							<b>blood collection / urine tubes</b>							

Adapter															
boring Ø x L in mm	13 x 58	13 x 58	17,5 x 60	17,5 x 60	26 x 72	36 x 79	45 x 78	13,5 x 58	13 x 58	17,5 x 60	13 x 58	13,5 x 58	17,5 x 60	17,5 x 60	17,5 x 60
vessels per rotor	180 / 120	180 / 120	114 / 76	114 / 76	42 / 28	24 / 16	12 / 8	126 / 84	180 / 120	114 / 76	180 / 120	126 / 84	114 / 76	114 / 76	114 / 76
<b>Cat. No.</b>	<b>4433</b>	<b>4433</b>	<b>4434</b>	<b>4434</b>	<b>4438</b>	<b>4439</b>	<b>4442</b>	<b>4435</b>	<b>4433</b>	<b>4434</b>	<b>4433</b>	<b>4435</b>	<b>4434</b>	<b>4434</b>	<b>4434</b>

Vessels															
capacity in ml	1.6 - 5	4 - 7	4 - 7	8	8.5 - 10	15	50	25	30	10	250	290	650	750	1.000
Ø x L in mm	13x75	13x100	16x75	16 x 125	16x100	17x120	29x115	25x90	25x110	16 x 80	62 x 122	62 x 137	97 x 139	97 x 152	96 x 176
max. RCF <sup>2)</sup> Rotor 4176 / 4174	5,841 / 5,026	5,841 / 5,026	5,977 / 5,184	5,977 / 5,184	5,977 / 5,184	6,090 / 5,298	6,090 / 4,958	5,909 / 5,117	5,909 / 5,117	5,977 / 5,184	6,203 / 5,411	6,203 / 5,411	6,384 / 5,592	6,384 / 5,592	6,384 / 5,592
radius in mm	258 / 222	258 / 222	264 / 229	264 / 229	264 / 229	269 / 234	269 / 219	261 / 226	261 / 226	264 / 229	274 / 239	274 / 239	282 / 247	282 / 247	282 / 247
<b>Cat. No.</b>	<b>blood collection / urine tubes</b>					<b>tubes with screw cap</b>					<b>5127<sup>24)</sup></b>	<b>-<sup>24)</sup></b>	<b>0554<sup>24)</sup></b>	<b>0512<sup>24)</sup></b>	<b>4239<sup>24)</sup></b>

Adapter															
boring Ø x L in mm	13,5 x 58	13,5 x 58	17,5 x 60	17,5 x 60	17,5 x 60	17 x 86	30 x 87	26 x 72	26 x 72	17,5 x 60	62x92	62x92	98 x 141	98 x 141	98 x 141
vessels per rotor	126 / 84	126 / 84	114 / 76	114 / 76	114 / 76	72 / 48	30 / 20	42 / 28	42 / 28	114 / 76	6 / 4	6 / 4	6 / 4	6 / 4	6 / 4
<b>Cat. No.</b>	<b>4435</b>	<b>4435</b>	<b>4434</b>	<b>4434</b>	<b>4434</b>	<b>4437</b>	<b>4441</b>	<b>4438</b>	<b>4438</b>	<b>4434</b>	<b>4443</b>	<b>4443</b>	-	-	-

Vessels						
capacity in ml	175	175	200	225	250	500
Ø x L in mm	61 x 118	61,5x144,3	60x130	61 x 137	60 x 162	96 x 147
max. RCF <sup>2)</sup> Rotor 4176 / 4174	6,384 / 5,592	6,384 / 5,592	6,384 / 5,592	6,384 / 5,592	6,384 / 5,592	6,384 / 5,592
radius in mm	282 / 247	282 / 247	282 / 247	282 / 247	282 / 247	282 / 247
<b>Cat. No.</b>	<b>Falcon®</b>	<b>Nalgene®</b>	<b>Nunc®</b>	<b>Falcon®</b>	<b>Corning®</b>	<b>Corning®</b>

Adapter						
boring Ø x L in mm	-	-	-	-	-	-
vessels per rotor	6 / 4	6 / 4	6 / 4	6 / 4	6 / 4	6 / 4
<b>Cat. No.</b>	<b>4440</b>	<b>4430</b>	<b>4430</b>	<b>4440</b>	<b>4430</b>	<b>4449</b>

- 1) For cooled versions: Lowest temperature achievable with precooling and max. speed.
- 2) Please note that the RCF values indicated refer only to rotor performance. The max. permissible RCF of tubes used should be verified with the individual manufacturers. The max. RCF for glass tubes annotated with footnote 2) is 4,000.
- 3.17) When using these tubes, bucket 4547-B cannot be closed with lid 5621.
- 24) At temperatures of over +40 °C and / or when not filled to capacity, bottles may warp during centrifugation.



## SWING-OUT ROTOR, 6- / 4-PLACE | 4176 / 4174



Rotor	
max. RPM	4,500 min <sup>-1</sup>
max. RCF	Rotor 4176 / 4174 5,999 / 5,184
max. capacity	6x750 ml
run-up   run-down, braked in sec	125   197
angle   temperature in °C <sup>1)</sup>	90°   +14 / -1
<b>Cat. No.</b>	<b>4176 / 4174</b>



Bucket	
<b>Cat. No.</b>	<b>4572</b>

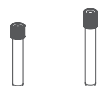

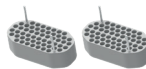

Vessels	
capacity in ml	4 – 7
Ø x L in mm	13x75
max. RCF	Rotor 4176 / 4174 5,818 / 5,003
radius in mm	257 / 221
<b>Cat. No.</b>	<b>blood collection tubes</b>



Adapter	
boring Ø x L in mm	13.2 x 59
vessels per rotor	336 / 224
<b>Cat. No.</b>	<b>4493</b>

## ANGLE ROTOR, 6-PLACE | 4570













Rotor	
max. RPM   max. RCF	6,000 min <sup>-1</sup>   5,594
max. capacity	6x250 ml
run-up   run-down, braked in sec	64   69
angle   max. noise level	25°   54 dB(A)
temperature in °C <sup>1)</sup>	-16
<b>Cat. No.</b>	<b>4570</b>



Lid bioseal <sup>®</sup> and phenol-resistant	
<b>Cat. No.</b>	<b>INCLUSIVE</b>



Vessels										
capacity in ml	15	25	94	15	50	10	30	50	85	250
Ø x L in mm	17x100	24x100	38x102	17x120	29x115	16x80	26x95	29x107	38 x 106	61.5x122
max. RCF <sup>2)</sup>	5,315	5,152	4,910	5,152	4,830	5,353	5,152	4,830	4,910	5,594
radius in mm	132	128	122	128	120	133	128	120	122	139
<b>Cat. No.</b>	<b>tubes<sup>2)</sup></b>			<b>tubes with screw cap</b>						<b>5127<sup>24)</sup></b>

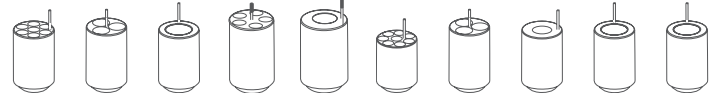

Adapter	
boring Ø x L in mm	17.6 x 83
vessels per rotor	42
<b>Cat. No.</b>	<b>5646</b>

1) For cooled versions: Lowest temperature achievable with precooling and max. speed.  
 2) Please note that the RCF values indicated refer only to rotor performance. The max. permissible RCF of tubes used should be verified with the individual manufacturers. The max. RCF for glass tubes annotated with footnote 2) is 4,000.  
 5) Tested by the TÜV in conformity with DIN EN 61010, section 2 - 020.  
 24) At temperatures of over +40 °C and / or when not filled to capacity, bottles may warp during centrifugation.

## ACCESSORIES FOR CENTRIFUGING BLOOD BAG SYSTEMS



### Hettliner

Blood bags can be secured in adapters using HettLiners. After centrifuging, they can be removed by their loops without disturbing the delicate separation of blood components.

**Cat. No. 4564**

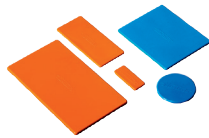

### Set of compensatory weights

If blood bag carriers are not filled to the same weight, then compensatory weights can be used to make up the difference. One set includes:  
 40 balancing weights, 2 g each;  
 20 balancing weights, 5 g each;  
 10 balancing weights, 10 g each;  
 5 balancing weights, 20 g each;  
 5 balancing weights, 40 g each

**Cat. No. 4566**



### Balancing inserts

In case there are not enough blood bag systems to occupy every carrier of the rotor, empty carriers can be filled with balancing inserts. Taring weights supplied with the inserts may be used for fine balancing.

**4584-A** for insert 4559-A

**4587-A** for insert 4592-B

**4589-A** for insert 4516-A



### Loading station

Secure your samples and avoid accidental spillage with the convenient Loading Station for centrifuge inserts. The Hettich Loading Station allows users to confidently hold and manage their samples without the risk of the inserts toppling over.

**Cat. No. 4509**

## CERTIFICATIONS / REGISTRATIONS

Product certification:



Product registration:



Company certifications:



## DIMENSIONS

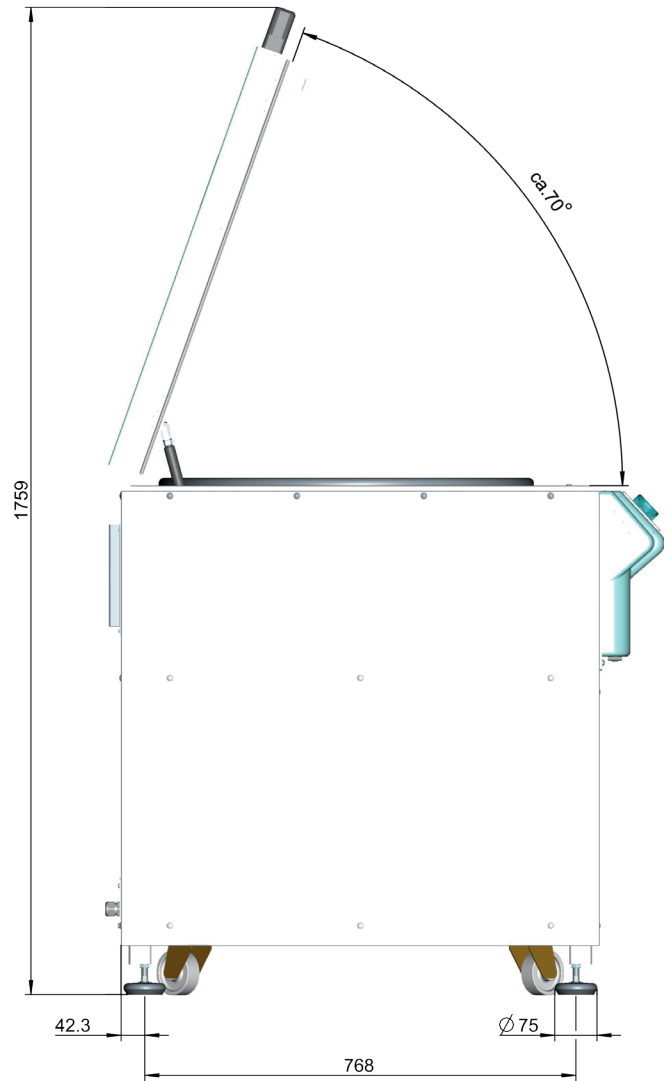
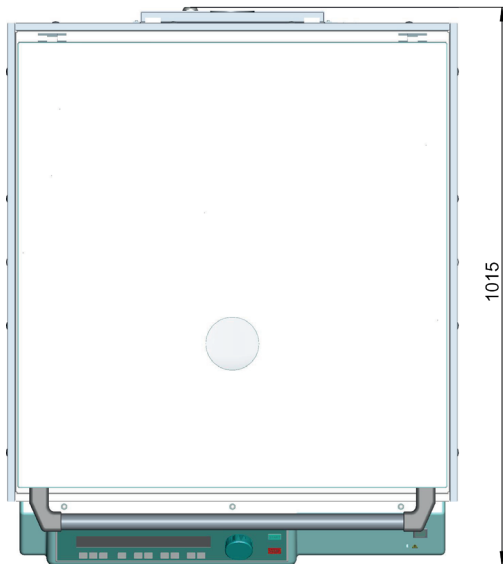
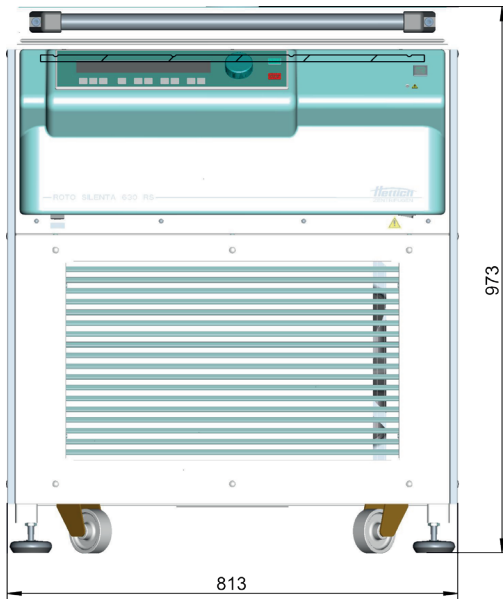



# WolfLabs

**Pricing on any accessories shown can be found by keying the part number into the search box on our website.**

The specifications listed in this brochure are subject to change by the manufacturer and therefore cannot be guaranteed to be correct. If there are aspects of the specification that must be guaranteed, please provide these to our sales team so that details can be confirmed.

**[www.wolflabs.co.uk](http://www.wolflabs.co.uk)**

**Tel : 01759 301142**

**Fax : 01759 301143**

**[sales@wolflabs.co.uk](mailto:sales@wolflabs.co.uk)**

Please contact us if this literature doesn't answer all your questions.